

SHUTTERS & SIDING ACCESSORIES CATALOG

LOUVER SHUTTERS | PANEL SHUTTERS | MOUNTING BLOCKS | GABLE VENTS



LARGE VARIETY OF STYLES & COLORS | EASY INSTALLATION | MAINTENANCE FREE

TRI-BUILT® STANDARD OPEN LOUVER SHUTTER



16 Colors 001, 002, 004, 008, 009, 010, 018, 023, 027, 028, 036, 078, 117, 122, 166, 167 and paintable (030)
 Widths 12" and 14 1/2"
 (widths are nominal)
 Lengths 25", 31", 36", 39", 43", 48", 52", 55", 60", 64", 67", 72", 75", & 80" (lengths are nominal)
 Packaged Shutters 43" and under receive 8 pack of Shutter-Loks®.
 Shutters over 47" receive 12 pack of Shutter-Loks®.

Size	Item #	Size	Item #
12" x 25"	00 01 1225 ***	14 1/2" x 25"	00 01 1425 ***
12" x 31"	00 01 1231 ***	14 1/2" x 31"	00 01 1431 ***
12" x 36"	00 01 1236 ***	14 1/2" x 36"	00 01 1436 ***
12" x 39"	00 01 1239 ***	14 1/2" x 39"	00 01 1439 ***
12" x 43"	00 01 1243 ***	14 1/2" x 43"	00 01 1443 ***
12" x 48"	00 01 1248 ***	14 1/2" x 48"	00 01 1448 ***
12" x 52"	00 01 1252 ***	14 1/2" x 52"	00 01 1452 ***
12" x 55"	00 01 1255 ***	14 1/2" x 55"	00 01 1455 ***
12" x 60"	00 01 1260 ***	14 1/2" x 60"	00 01 1460 ***
12" x 64"	00 01 1264 ***	14 1/2" x 64"	00 01 1464 ***
12" x 67"	00 01 1267 ***	14 1/2" x 67"	00 01 1467 ***
12" x 72"	00 01 1272 ***	14 1/2" x 72"	00 01 1472 ***
12" x 75"	00 01 1275 ***	14 1/2" x 75"	00 01 1475 ***
12" x 80"	00 01 1280 ***	14 1/2" x 80"	00 01 1480 ***

TRI-BUILT® STANDARD RAISED PANEL SHUTTER



16 Colors 001, 002, 004, 008, 009, 010, 018, 023, 027, 028, 036, 078, 117, 122, 166, 167 and paintable (030)
 Widths 12" and 14 3/4" (widths are nominal)
 Lengths 31", 35", 39", 43", 47", 51", 55", 59", 63", 67", 67" Cottage Style, 71", 75", & 80"
 (lengths are nominal)
 Packaged Shutters 43" and under receive 8 pack of Shutter-Loks®.
 Shutters over 46" receive 12 pack of Shutter-Loks®.

Size	Item #	Size	Item #
12" x 31"	00 02 1231 ***	14 3/4" x 31"	00 02 1431 ***
12" x 35"	00 02 1235 ***	14 3/4" x 35"	00 02 1435 ***
12" x 39"	00 02 1239 ***	14 3/4" x 39"	00 02 1439 ***
12" x 43"	00 02 1243 ***	14 3/4" x 43"	00 02 1443 ***
12" x 47"	00 02 1247 ***	14 3/4" x 47"	00 02 1447 ***
12" x 51"	00 02 1251 ***	14 3/4" x 51"	00 02 1451 ***
12" x 55"	00 02 1255 ***	14 3/4" x 55"	00 02 1455 ***
12" x 59"	00 02 1259 ***	14 3/4" x 59"	00 02 1459 ***
12" x 63"	00 02 1263 ***	14 3/4" x 63"	00 02 1463 ***
12" x 67"	00 02 1267 ***	14 3/4" x 67"	00 02 1467 ***
12" x 67" cottage style		14 3/4" x 67" cottage style	
	00 02 6712 ***		00 02 6714 ***
12" x 71"	00 02 1271 ***	14 3/4" x 71"	00 02 1471 ***
12" x 75"	00 02 1275 ***	14 3/4" x 75"	00 02 1475 ***
12" x 80"	00 02 1280 ***	14 3/4" x 80"	00 02 1480 ***

TRI-BUILT® STANDARD BOARD-N-BATTEN SHUTTERS

16 Colors 001, 002, 004, 008, 009, 010, 018, 023, 027, 028, 036, 078, 117, 122, 166, 167 and paintable (030).

Widths
 Spaced - 12"
 Joined - 14"

Lengths
 From 31" to 80" Shutters under 55" in length will have 2 cross battens. Shutters 55" and over will have 3 cross battens. Lengths and widths are nominal.

Packaged: Boxed pairs with 12 screws.

*NOTE: When ordering 4-Board Joined with Arch Top shutters add 7" to the window opening height to determine total shutter height. For example: 50" high window opening + 7" arch = 57" shutter.

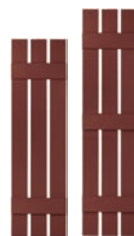
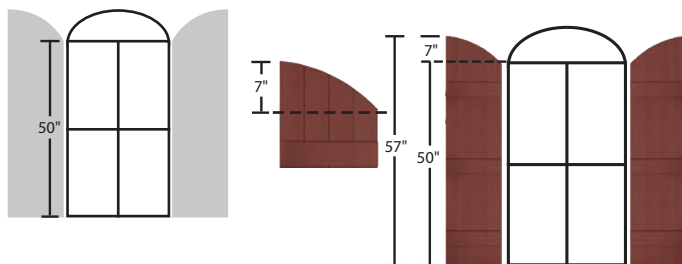

12" Width
3-Board Spaced

Size	Item #
12" x 31"	00 03 1231***
12" x 35"	00 03 1235***
12" x 39"	00 03 1239***
12" x 43"	00 03 1243***
12" x 47"	00 03 1247***
12" x 51"	00 03 1251***
12" x 55"	00 03 1255***
12" x 59"	00 03 1259***
12" x 63"	00 03 1263***
12" x 67"	00 03 1267***
12" x 71"	00 03 1271***
12" x 75"	00 03 1275***
12" x 80"	00 03 1280***



14" Width
4-Board joined

Size	Item #
14" x 31"	00 03 1431***
14" x 35"	00 03 1435***
14" x 39"	00 03 1439***
14" x 43"	00 03 1443***
14" x 47"	00 03 1447***
14" x 51"	00 03 1451***
14" x 55"	00 03 1455***
14" x 59"	00 03 1459***
14" x 63"	00 03 1463***
14" x 67"	00 03 1467***
14" x 71"	00 03 1471***
14" x 75"	00 03 1475***
14" x 80"	00 03 1480***

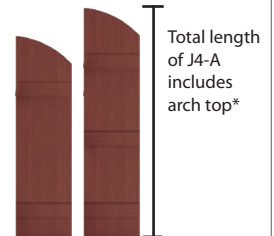

14" Width
4-Board joined w/arch top

Size	Item #
14" x 45"	00 33 1445***
14" x 49"	00 33 1449***
14" x 53"	00 33 1453***
14" x 57"	00 33 1457***
14" x 61"	00 33 1461***
14" x 65"	00 33 1465***
14" x 69"	00 33 1469***
14" x 73"	00 33 1473***
14" x 77"	00 33 1477***
14" x 81"	00 33 1481***
14" x 85"	00 33 1485***
14" x 89"	00 33 1489***
14" x 94"	00 33 1494***

***Indicates add color code numbers.

TRI-BUILT® SHUTTER ACCESSORIES

Product	Packaged	Item #	Color
Shutter-Lok®	12 per bag	00 97 3012 ***	Stock Colors & paintable (030)
Shutter-Lok®	10 pack (12 pack bags)	00 97 5010 ***	Stock Colors & paintable (030)
Shutter-Lok®	50 pack (12 pack bags)	00 97 5050 ***	Stock Colors & paintable (030)
Shutter-Lok® (Bulk)	1000 loose	00 97 3001 ***	Stock Colors & paintable (030)
Decorative Hinge & S-Hook	4 Hinges, 2 Hooks/bag, 6 Bags/box	00 97 0642 002	Black
3" Painted Screws	12 per bag	00 97 2012 ***	Stock Colors & paintable (030)
3" Painted Screws (Bulk)	1000 loose pieces	00 61 1000 ***	Stock Colors & paintable (030)
Shutter Clips †	12 per bag	00 61 2000 000	
Ferrule	1 piece	00 97 3021 000	
Ferrule	100 per box	00 97 3022 000	
Louver Mini Shutters	35/8" x 115/8" - each	00 08 6495 ***	Available in 16 Stock
Panel Mini Shutters	35/8" x 115/8" - each	00 08 5496 ***	Available in 16 Stock

Shutter-Lok®



U.S. Patent No. 4,381,633

Ferrule

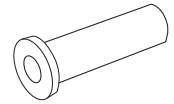

Mini Shutters



Decorative Hinge and S-Hook



TRI-BUILT® SHUTTER TOPS



Quarter Round Arch Top
Raised Panel

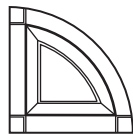

14¾" x 14¾"
12" x 12"



Quarter Round Arch top
Solid



14½" x 17"



Quarter Round Arch Top
Open Louver



14½" x 17"



6" Elliptical
Arch top



14¾" x 6"



Transom Top
Add-On

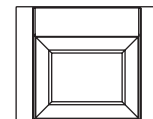

14¾" x 11¾"
12" x 12"

Product	Size	Item #	Packaged	Use With
Quarter Round Arch Top	14¾" Raised Panel	00 97 0003 ***	Boxed pair with clips.	14¾" Standard Raised Panel Shutter only
	12" Raised Panel	00 97 1200 ***		12" Standard Raised Panel Shutter only
	14½" Solid	00 97 0004 ***	Boxed pair with clips.	14½" Standard Louver Shutter only
	14½" x 17" Louver	00 97 0002 ***		14½" Standard Louver Shutter only
6" Elliptical	14¾" x 6"	00 97 0601 ***	Boxed pair with clips.	14¾" Standard Raised Panel Shutter only
Transom Top	14¾" x 11¾"	00 97 1411 ***	Boxed pair with clips.	14¾" Standard Raised Panel Shutter only
	12" x 12"	00 97 1211 ***	Boxed pair with clips.	12" Standard Raised Panel Shutter only

16 Colors 001, 002, 004, 008, 009, 010, 018, 023, 027, 028, 036, 078, 117, 122, 166, 167 and paintable (030).

Packaged: Boxed pairs with clips.

***Indicates add color code numbers.

WATER MANAGEMENT MOUNTING BLOCKS

MOUNT - WM

Available in our full color offering.

Item # 00 03 7101*** 10 per box
 Item # 00 03 7111*** 1 per box

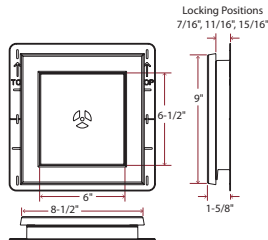

Horizontal Recessed Mount - WM

Available in our full color offering

Item # 00 03 7201*** 10 per box
 Item # 00 03 7211*** 1 per box

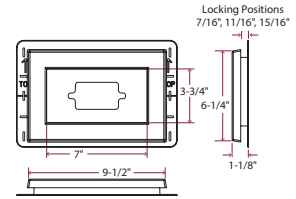

Jumbo - WM

Available in our full color offering.

Item # 00 03 7701*** 10 per box
 Item # 00 03 7711*** 1 per box

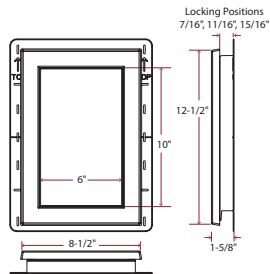

Split Block - WM

Available in our full color offering.

Item # 00 03 7401*** 10 per box
 Item # 00 03 7411*** 1 per box

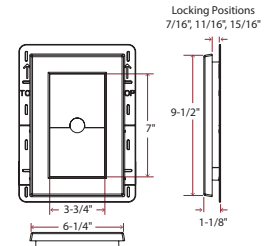

4" Hooded Vent - WM

Available in our full color offering.

Colors Item # 00 03 7805*** 1 per box
 White & Paintable Item # 00 03 7804*** 4 per box
 White & Paintable Item # 00 03 7814*** 1 per box

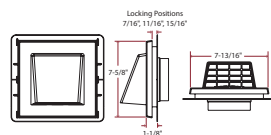

Small Animal Guard for 4" Hooded Vent - WM

Available in 001, 002, 023, 030

Colors Item # 00 98 0707*** 1 per box

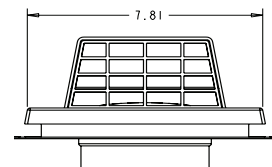

Wire Screen for 4" Hooded Vent - WM

Item # 00 98 0876 000 1 per box

***Indicates add color code numbers.

MOUNT BLOCKS & UTILITY VENTS FOR INSULATED SIDING

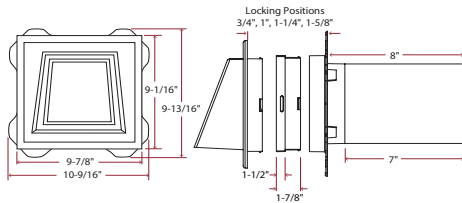
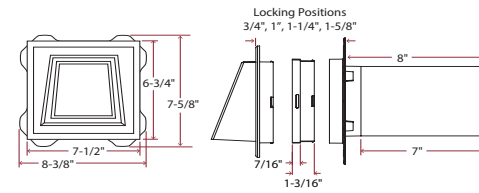

4" Hooded Vent for Insulated Siding

White (001) & Paintable (030) Item # 00 03 5804 *** 4 per box
 White (001) & Paintable (030) Item # 00 03 5814 *** 1 per box
 Colors Item # 00 03 5805 *** 1 per box

- Locking positions .75", 1.00", 1.25", 1.50"
- Concealed exhaust flap.
- Includes 7" long aluminum tube (4" dia).
- 12 sq. in. net free ventilation area
- 1/4" Wire screen available, ordered separately Item # 00980886000

6" Hooded Vent for Insulated Siding

Colors Item # 00 03 6806 *** 1 per box

- Locking positions .75", 1.00", 1.25", 1.625"
- Concealed exhaust flap.
- Wire screen included.
- Includes 7" long aluminum tube.
- 25 sq. in. net free ventilation area.

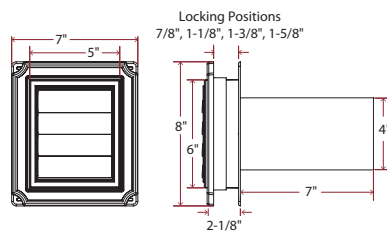

Exhaust Vent for Insulated Siding

Scalloped Item # 00 03 5801 *** 4 per box
 Scalloped Item # 00 03 5811 *** 1 per box

- Locking positions .875", 1.125", 1.375", 1.625"
- Exhaust flaps stay closed when not in use.
- Lock-On Trim Ring simplifies installation.
- Includes 7" long aluminum tube (4" dia.).
- 12 sq. in. net free ventilation area

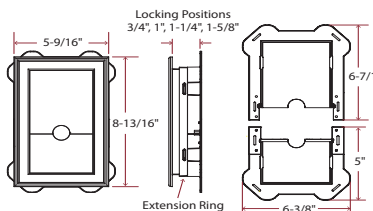

Split Block for Insulated Siding

Item # 00 03 5401 *** 10 per box
 Item # 00 03 5411 *** 1 per box

- Locking positions .75", 1.00", 1.25", 1.625"
- Ring and block split apart.
- Block splits apart.
- Fits around existing pipes and wires.

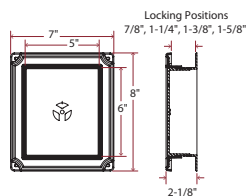

Original Mount for Insulated Siding

Scalloped Item # 00 03 5101 *** 10 per box
 Scalloped Item # 00 03 5111 *** 1 per box

- Locking positions .875", 1.125", 1.375", 1.625"
- Provides level and waterproof surface for all exterior accessories.

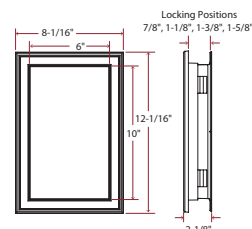

Jumbo Mount for Insulated Siding

Item # 00 03 5701 *** 10 per box
 Item # 00 03 5711 *** 1 per box

- Locking positions .875", 1.125", 1.375", 1.625"
- For coach lamps, etc.

***Indicates add color code numbers.

Mount Blocks are available in full color offering

See page 15 for color chart

UL® LISTED ELECTRICAL MOUNT BLOCKS

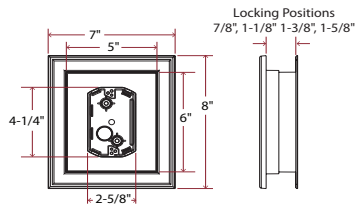

Electrical Block

White (001) & Paintable (030)	Item # 00 03 1001 ***	10 per box
White (001) & Paintable (030)	Item # 00 03 1110 ***	1 per box
Colors	Item # 00 03 1002 ***	2 per box
Colors	Item # 00 03 1110 ***	1 per box

- Locking positions .875", 1.125", 1.375", 1.625"
- Electrical mounting block with UL listed 18 cu. in. outlet box.
- Can be used on standard or insulated siding.

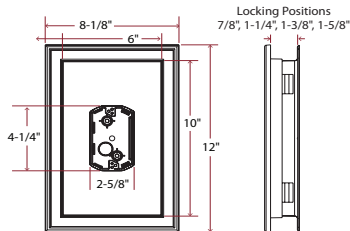

Jumbo Electrical Block – Centered

White (001) & Paintable (030)	Item # 00 03 2011 ***	10 per box
White (001) & Paintable (030)	Item # 00 03 2111 ***	1 per box
Colors	Item # 00 03 2022 ***	2 per box
Colors	Item # 00 03 2111 ***	1 per box

- Locking positions .875", 1.125", 1.375", 1.625"
- Electrical mounting block with UL listed 18 cu. in. outlet box.
- Can be used on standard or insulated siding.

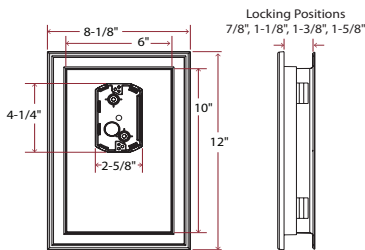

Jumbo Electrical Block – Offset

White (001) & Paintable (030)	Item # 00 03 2010 ***	10 per box
White (001) & Paintable (030)	Item # 00 03 2110 ***	1 per box
Colors	Item # 00 03 2002 ***	2 per box
Colors	Item # 00 03 2110 ***	1 per box

- Locking positions .875", 1.125", 1.375", 1.625"
- Electrical mounting block with UL listed 18 cu. in. outlet box.
- Can be used on standard or insulated siding.

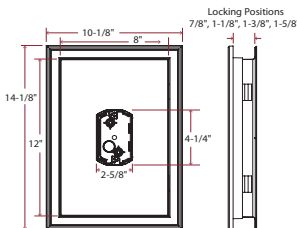

Super Jumbo Electrical Block

White (001) & Paintable (030)	Item # 00 03 3011 ***	4 per box
White (001) & Paintable (030)	Item # 00 03 3111 ***	1 per box
Colors	Item # 00 03 3001 ***	1 per box

- Locking positions .875", 1.125", 1.375", 1.625"
- For larger coach lamps and smaller electrical and water meters.
- Can be used on standard or insulated siding.

MOUNT BLOCKS

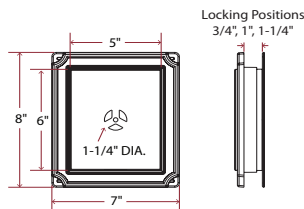

Original Mount

Scalloped	Item # 00 03 0101 ***	10 per box
	Item # 00 03 1101 ***	1 per box
Square	Item # 00 03 0102 ***	10 per box
	Item # 00 03 1102 ***	1 per box

- Locking positions .75", 1.00", 1.25"
- Provides level and waterproof surface for all exterior accessories.

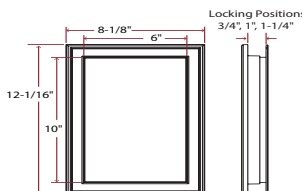

Jumbo Mount

Item # 00 03 2701 ***	10 per box
Item # 00 03 2101 ***	1 per box

- Locking positions .75", 1.00", 1.25"
- For larger coach lamps and smaller electrical and water meters.

***Indicates add color code numbers.

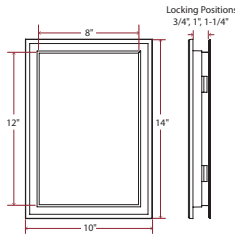

Super Jumbo Mount

White (001) & Paintable (030) Item # 00 03 2811 *** 4 per box
 White (001) & Paintable (030) Item # 00 03 1811 *** 1 per box
 Colors Item # 00 03 2801 *** 1 per box

- Locking positions .75", 1.00", 1.25"
- For larger coach lamps and smaller electrical and water meters.

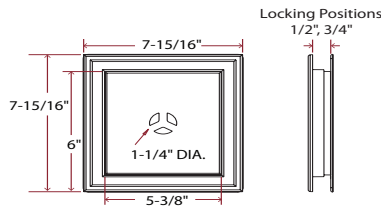

Slim Line

Item # 00 03 0103 *** 10 per box
 Item # 00 03 1103 *** 1 per box

- Locking positions .50", .75"
- Low profile for soffits, etc.
- Provides level and waterproof surface for all exterior accessories.

RECESSED MOUNT BLOCKS

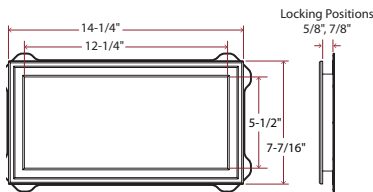

Recessed Jumbo

Item # 00 03 2201 *** 10 per box
 Item # 00 03 2211 *** 1 per box

- Locking positions .625", .875"
- Low profile, inset block.

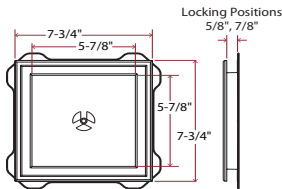

Recessed Square

Item # 00 03 0202 *** 10 per box
 Item # 00 03 1202 *** 1 per box

- Locking positions .625", .875"
- Low profile, inset block.

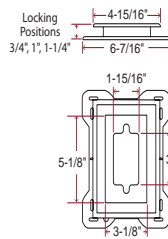

Recessed Mini

Item # 00 03 0201 *** 10 per box
 Item # 00 03 1201 *** 1 per box

- Locking positions .75", 1.00", 1.25"
- Low profile, inset block.

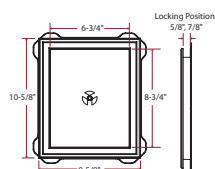

Large Recessed Mount

Item # 00 03 2401 *** 5 per box
 Item # 00 03 2411 *** 1 per box

- Locking positions .625", .875"
- Low profile, inset block.

***Indicates add color code numbers.

MOUNT BLOCKS

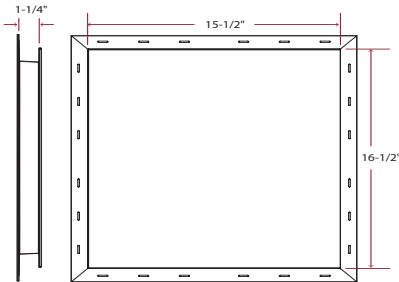

Meter Block

- | | | |
|-------------------------------|-----------------------|-----------|
| White (001) & Paintable (030) | Item # 00 03 0930 *** | 6 per box |
| White (001) & Paintable (030) | Item # 00 03 0931 *** | 1 per box |
| Colors | Item # 00 03 0901 *** | 1 per box |
- For meters and extra large fixtures.

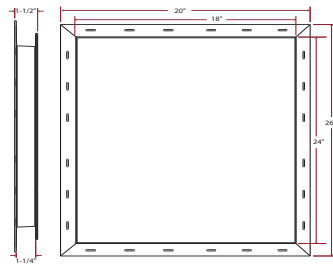

Jumbo Meter Block

- | | | |
|-------------------------------|-----------------------|-----------|
| White (001) & Paintable (030) | Item # 00 03 2930 *** | 4 per box |
| White (001) & Paintable (030) | Item # 00 03 2931 *** | 1 per box |
| Colors | Item # 00 03 2901 *** | 1 per box |
- For larger sized meters, mounts flush, built-in J-Channel.
 - Easy to install.
 - Screw or nail onto any surface.

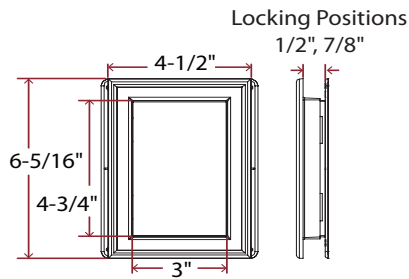

Mini

- | | |
|-----------------------|------------|
| Item # 00 03 0402 *** | 10 per box |
| Item # 00 03 1402 *** | 1 per box |
- Locking positions .50", .85"
 - For door bells, switches, outlets, etc.

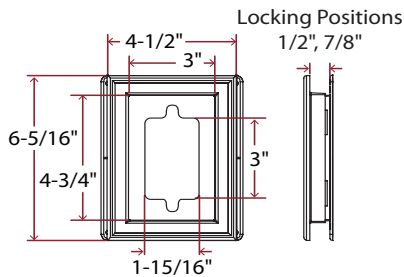

Mini Mount Pre-Cut

- | | |
|-----------------------|------------|
| Item # 00 03 0403 *** | 10 per box |
| Item # 00 03 1403 *** | 1 per box |
- Locking positions .50", .85"

***Indicates add color code numbers.

MOUNT BLOCKS

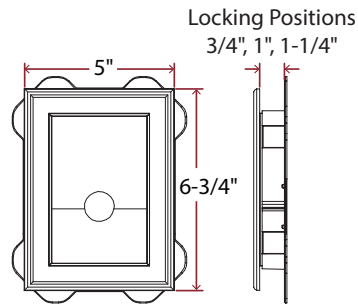

Split Block Mini

Item # 00 03 0401 *** 10 per box

Item # 00 03 1401 *** 1 per box

- Locking positions .75", 1.00", 1.25"
- Fits around existing pipes and wires.
- Block splits apart.

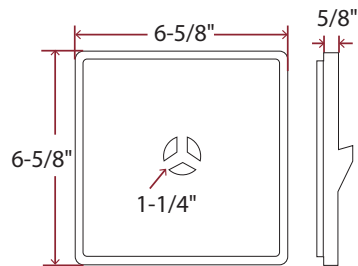

Surface Block for Dutch Lap Siding

Item # 00 03 0502 *** 10 per box

Item # 00 03 1502 *** 1 per box

- For installing fixtures, after the siding is up.

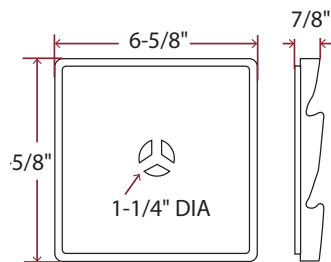

Surface Block for Triple 3" Siding

Item # 00 03 0503 *** 10 per box

Item # 00 03 1503 *** 1 per box

- For installing fixtures, after the siding is up.

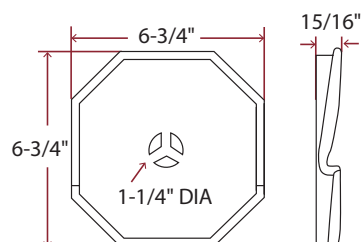

Surface Block for 4"-10" Siding

Item # 00 03 0504 *** 10 per box

Item # 00 03 1504 *** 1 per box

- For installing fixtures, after the siding is up.

***Indicates add color code numbers.

See page 15 for color chart

UTILITY VENTS

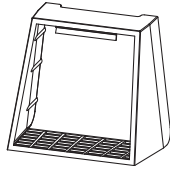

Optional Small Animal Guard
Not for Dryer Vent

Small Animal Guard for 4" Hooded Vent

Available in 001, 002, 023, plus Paintable (030).

Small Animal Guard Item # 00 98 0605 ***

1 per box

- Fits inside the vent.
- Order in addition to the 4" Hooded Vent.

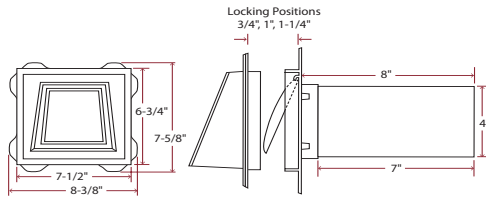

4" Hooded Vent

White (001) & Paintable (030) Item # 00 03 0804 ***

4 per box

White (001) & Paintable (030) Item # 00 03 1804 ***

1 per box

Colors Item # 00 03 0805 *** 1 per box

- Locking positions .75", 1.00", 1.25"
- 12 sq. in. net free ventilation area.
- Concealed exhaust flap.
- Wire Screen sold separately. Item # 00 98 0886 000

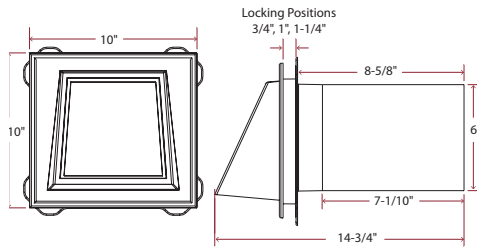

6" Hooded Vent

Item # 00 03 0806 *** 1 per box

- Locking positions .75", 1.00", 1.25"
- Concealed exhaust flap.
- Wire screen included.
- Includes 7" long aluminum tube.
- 25 sq. in. net free ventilation area.

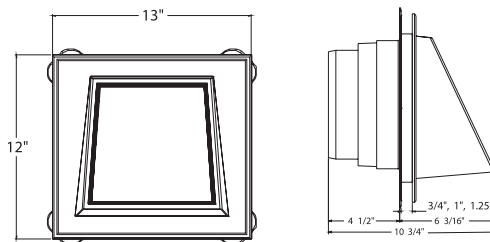

8" Hooded Vent

Item # 00 03 0808 *** 1 per box

- Meets the increased air flow requirements of newer high efficiency HVAC Systems.
- Can be installed with an 8" or 7" diameter tube (not included).
- Adapter for 7" diameter tube is included.
- Concealed exhaust flap.
- Wire screen included.
- 48 sq. in. net free ventilation area.

***Indicates add color code numbers.

UTILITY VENTS

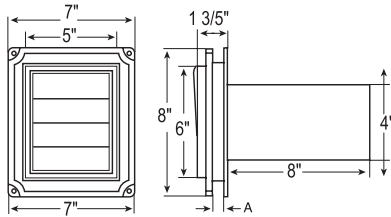

Exhaust Vent

- | | | |
|-----------|-----------------------|-----------|
| Scalloped | Item # 00 03 0801 *** | 4 per box |
| Scalloped | Item # 00 03 1801 *** | 1 per box |
| Square | Item # 00 03 0802 *** | 4 per box |
| Square | Item # 00 03 1802 *** | 1 per box |
- Locking positions .75", 1.00", 1.25"
 - 12 sq. in. net free ventilation area

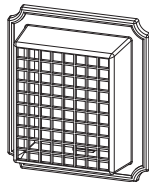

Optional Small Animal Guard

Small Animal Guard

For Exhaust Vent

- | | | |
|--------------------|-----------------------|-----------|
| Small Animal Guard | Item # 00 98 0606 *** | 1 per box |
|--------------------|-----------------------|-----------|
- Use in place of the trim ring.
 - Order in addition to the Master Exhaust Vent.

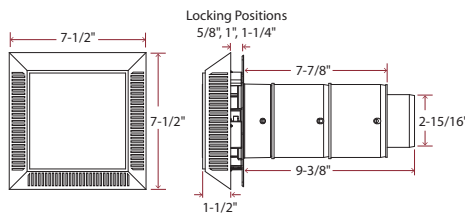

Intake / Exhaust Vent

- | | |
|-----------------------|-----------|
| Item # 00 03 0807 *** | 1 per box |
|-----------------------|-----------|
- Locking positions .625", 1.00", 1.25"
 - Full fiberglass screening.
 - (Not for use as a dryer or furnace vent.)
 - Adjustable Vent Tube adjusts from 1 1/2" to 8" and comes reduces from 4" to 3".
 - 12 sq. in. net free ventilation area

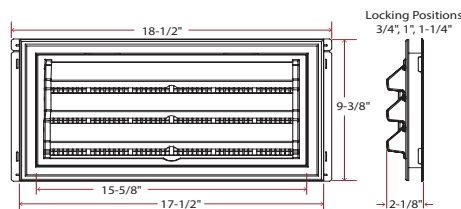

Foundation Master™ Kit - molded screen

- | | | |
|---------------|-----------------------|------------|
| Molded Screen | Item # 00 03 6400 *** | 10 per box |
| | Item # 00 03 6410 *** | 1 per box |
- 1/4" molded screen for insect protection
 - 50 sq. in. net free ventilation area
 - Includes optional fixed louver
 - For new construction or remodeling applications

Foundation Master™ Kit - wire screen

- | | |
|-----------------------|------------|
| Item # 00 03 6409 *** | 10 per box |
| Item # 00 03 6419 *** | 1 per box |
- 1/4" molded kit with galvanized wire screen for insect protection
 - 50 sq. in. net free ventilation area
 - Includes optional fixed louver
 - For new construction or remodeling applications

***Indicates add color code numbers.

GABLE VENTS OFFER PERFORMANCE, STYLE, VERSATILITY AND PROTECTION



Performance

TRI-BUILT® Gable Vents offer key features that have become the benchmark in the industry. Installation is easy with our wide nailing flange, leveling lines, adjustable stop gauge and snap-on trim ring. The snap-on trim ring hides rough cuts and reduces installation time, while providing a finished appearance once the vent has been installed. Each gable vent has more Net Free Ventilation Area for optimal venting than industry standards.

Style

TRI-BUILT® gable vents provide added architectural detail with their wood grain finish and sharp distinctive features. Choose from the most styles, sizes and colors in the industry to accent your home beautifully. Gable vents are also available in a paintable option for a custom look. These vents are easy to paint with a primer and acrylic paint.

Versatility

Installation is easy on all types of siding including vinyl, wood, fiber cement, stucco, brick or stone. Our gable vents work well in both new construction and remodeling applications. You also have the option of installing gable vents with a decorative application, when a functioning vent is not required. You can either install the vent over a substrate without cutting a vent hole or use the Non-Functional Gable Vents with closed louvers.

Protection

Our vents feature a double baffle design that blocks a direct view into the home and provides added protection against wind-driven rain and snow. The sealed-in fiberglass screen offers complete insect and animal protection.

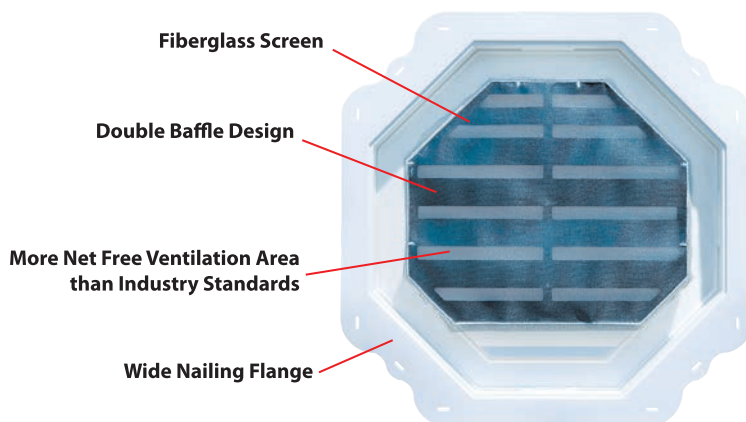
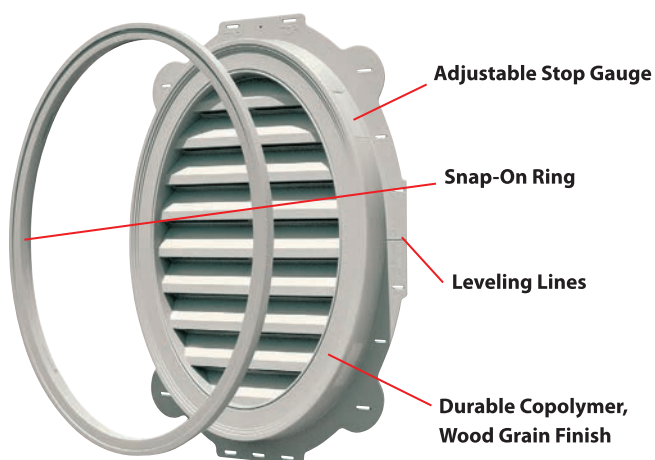

***Indicates add color code numbers.

DESIGNER SERIES GABLE VENTS



Designer 30" Round
with Keystones



Designer 28" Round
without Keystones

TRI-BUILT® DESIGNER SERIES GABLE VENTS

	Item #	O. D.	Depth	NFVA	Locking Positions
30" – Designer 30" Round w/ Keystones	00 41 0030 ***	30" diameter	2.156"	50 sq. in.	.25", .50", .75", 1.00", 1.25"
28" – Designer 28" Round w/o Keystones	00 41 0028 ***	28.25" diameter	2.156"	50 sq. in.	.75", 1.00", 1.25", 1.50"

STANDARD GABLE VENTS



Half Round



Oval



Octagon



Round



Round Top



Rectangle & Square

TRI-BUILT® STANDARD SERIES GABLE VENTS

	Item #	O. D.	Depth	NFVA	Locking Positions
Round Top					
14" x 22" K	00 44 1422 ***	16"x 24"	2.187"	50 sq. in.	.50", .75", 1.00", 1.25"
22" x 32" K	00 44 2232 ***	22"x 32"	2.187"	70 sq. in.	.50", .75", 1.00", 1.25"
Oval					
21" x 27" K	00 42 2127 ***	21"x 27"	2.175"	57 sq. in.	.75", 1.0", 1.25", 1.50"
Octagon					
18"	00 40 0018 ***	18" width	2"	26 sq. in.	.75", 1.0", 1.25", 1.50"
22" K *	00 40 0022 ***	22" width	2"	54 sq. in.	.75", 1.0", 1.25", 1.50", 1.625"
27" K	00 40 0027 ***	27" width	2"	81 sq. in.	.75", 1.0", 1.25", 1.50"
32" K	00 40 0032 ***	32" width	2"	110 sq. in.	.75", 1.0", 1.25", 1.50"
Round					
18"	00 41 0018 ***	18" diameter	2"	26 sq. in.	0", .25", .5", .75", 1.00", 1.25"
22" K *	00 41 0022 ***	22" diameter	2"	50 sq. in.	.75", 1.00", 1.25", 1.5", 1.625"
36" K	00 41 0036 ***	36" diameter	2"	140 sq. in.	.75", 1.00", 1.25", 1.5"
Half Round					
34" x 22" K	00 43 2234 ***	22.1" x 34.2"	2.1"	100 sq. in.	.75", 1.0", 1.25", 1.50"
Rectangle / Square					
12" x 12" - Colors / Paintable*	00 46 1212 ***	14.2"x 14.2" 1.75"		38 sq. in.	.50", .75", 1.00", 1.25", 1.625"
12" x 12" - White (5 pack)*	00 46 1205 001	14.2"x 14.2" 1.75"		38 sq. in.	.50", .75", 1.00", 1.25", 1.625"
12" x 18" - Colors / Paintable*	00 45 1218 ***	14"x 20" 1.75"		36 sq. in.	.50", .75", 1.00", 1.25", 1.625"
12" x 18" - White (5 pack)*	00 45 1805 001	14"x 20" 1.75"		36 sq. in.	.50", .75", 1.00", 1.25", 1.625"
18" x 24" Classic Style K	00 45 2401 ***	20.2"x 26.2" 2.18"		63 sq. in.	.50", .75", 1.00", 1.25"
18" x 24" - Colors / Paintable*	00 45 1824 ***	20.2"x 26" 1.75"		140 sq. in.	.50", .75", 1.00", 1.25", 1.625"
18" x 24" - White (5 pack)*	00 45 2405 001	20.2"x 26" 1.75"		140 sq. in.	.50", .75", 1.00", 1.25", 1.625"
20" x 30" Classic Style K *	00 45 2430 ***	22.625" x 32.625" 1.75"		298 sq. in.	.75", 1.25", 1.625"

Gable Vent Keystone
00 40 0000 ***



K=Keystones available.
Modifications need to be made in the field for a keystone to fit except for:
22" Octagon
22" Round
22" x 34" Half Round vents

O.D.= Outside Dimensions (outside of ring to outside of ring)

Depth= Thickness
NFVA= Net Free Ventilation Area (square inches)

***Indicates add color code numbers.

SPECIALTY GABLE VENT



Triangle

- Sonically welded vents.
- Style-A-Vents & Specialty Vents are only available in White (001) and Paintable (030). Not part of 25 minimum color offering.

Product Specs available upon request	Item #	Pitch	O.D.	Depth	NFVA Sq. In.	Locking Position
TRIANGLE						
Triangle – 14.5" x 74"	00 47 0404 ***	4/12 Pitch	14.5"x 74"	2.125"	56	.625", .875", 1.125", 1.375"
Triangle – 17" x 70.5"	00 47 0505 ***	5/12 Pitch	16.9"x 70.5"	2.125"	74	.625", .875", 1.125", 1.375"
Triangle – 18" x 72.5"	00 47 0605 ***	6/12 Pitch	18.1"x 72.5"	2.125"	61	.625", .875", 1.125", 1.375"
Triangle – 20.5" x 70.5"	00 47 0706 ***	7/12 Pitch	20.5"x 70.5"	2.125"	81	.625", .875", 1.125", 1.375"
Triangle – 21" x 62.5"	00 47 0806 ***	8/12 Pitch	20.8"x 62.5"	2.125"	69	.625", .875", 1.125", 1.375"
Triangle – 23"x 62"	00 47 0907 ***	9/12 Pitch	23.1"x 61.8"	2.125"	89	.625", .875", 1.125", 1.375"
Triangle – 23" x 56"	00 47 1007 ***	10/12 Pitch	23.4"x 56"	2.125"	77	.625", .875", 1.125", 1.375"
Triangle – 26" x 56"	00 47 1108 ***	11/12 Pitch	25.8"x 56.3"	2.125"	96	.625", .875", 1.125", 1.375"
Triangle – 26" x 52"	00 47 1208 ***	12/12 Pitch	26"x 52"	2.125"	88	.625", .875", 1.125", 1.375"
Triangle – 17" x 34"	00 47 1204 ***	12/12 Pitch	17"x 34.1"	2.125"	19	.625", .875", 1.125", 1.375"

***Indicates add color code numbers.

COLOR PROGRAM

STOCK SHUTTER COLORS*



*All blocks are available in full color offering (250+ colors).
Actual colors may vary from printed representations.

Standard Shutters:

Louver, Raised Panel, and Board-n-batten

17 Colors: 001, 002, 004, 008, 009, 010, 018, 023, 027, 028, 036, 078, 117, 122, 166, 167 and paintable (030)

Non-Stock

Color Program: Louver and Raised Panel Only

Louver and Raised Panel Standard sized shutters can be produced in any color. This program is designed to provide color options on large scale projects. The lead time is 4 weeks and orders are non-cancellable and non-returnable. 25 pair minimum.

Custom Color Program:

Standard Shutters can be produced in a custom color. Minimum order size of 100 pairs per color, per size. Different size shutters or colors cannot be combined to achieve the minimum order. Custom color orders have a 10 week lead time. Orders are non-cancelable and non-returnable. Additional charges apply.

STOCK VENT COLORS



Mount Block Utility Vent Color Program

Available in our full color offering.

All Mount Blocks including Standard, Water Management, Insulated Siding.

All Utility Vents including Standard, Water Management, Insulated Siding.

Foundation Master is available in the 24 stock colors plus paintable.

*Available in our full page color offering with a 3 box minimum.

Gable Vent Color Program

001, 002, 008, 011, 012, 013, 016, 020, 021, 023, 028, 034, 045, 048, 049, 069, 078, 082, 085, 089, 095, 097, 117, 123 and Paintable (030).

***Indicates add color code numbers.

